

ACTUATOR PLUG WIRING ENDS

Item #	Qty.	Description	
1	1	Male Connector	P800481
2	3	Loose Male Terminal	P800510
3	3	Cable Seal	P800466
4	1	Lock Clip	P800502

Item #	Qty.	Description	
1	1	Female Connector	P800464
2	3	Loose Female Terminal	P800465
3	3	Cable Seal	P800466
4	1	Lock Clip	P800502

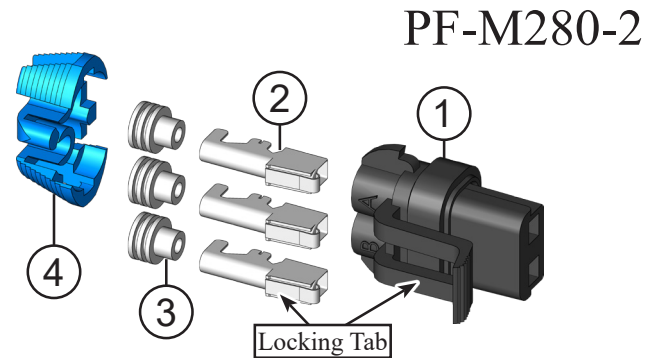
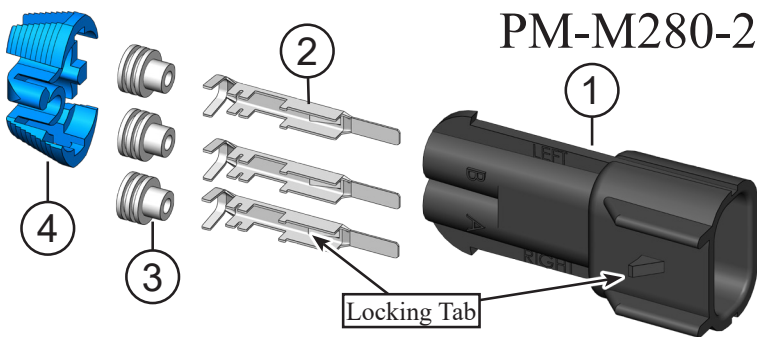

Note: Make sure all hardware needed to complete this mount is in the package. Thoroughly read through and understand the instructions before installing. Male and female plugs purchased individually, installation is identical for either.

Refer to the Wire Crimpers shown below for proper crimping technique.

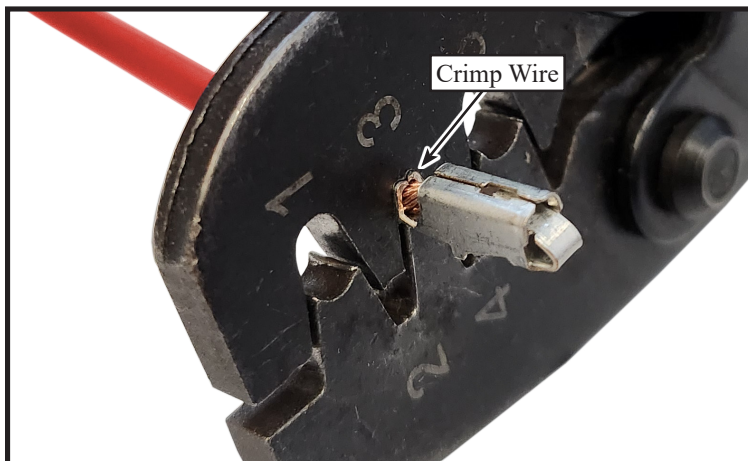

ACTUATOR PLUG WIRING ENDS

1. Cut red and black wires to an even length and strip $\frac{3}{8}$ " of insulation from both as shown in **Figure 1**.

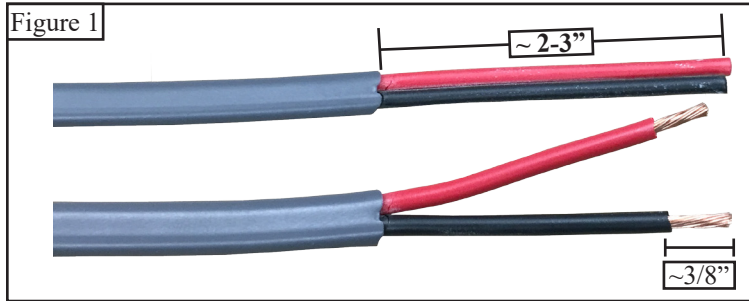

2. Place Cable Seal (3) over the wire, flush with the insulation as shown in **Figure 2**.

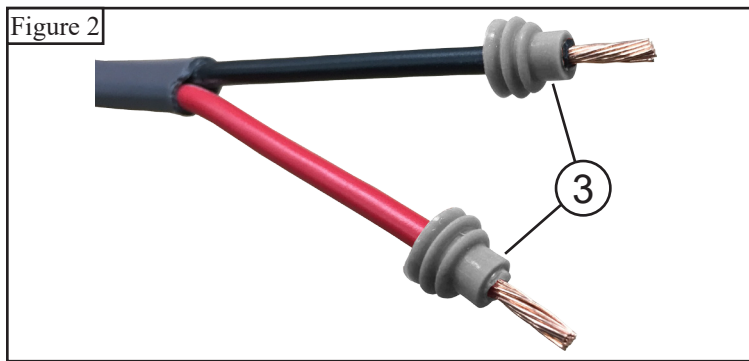

3. Place Terminal (2) over bare copper wire flush with cable seal (3) as shown in **Figure 3**.
NOTE: Be sure terminal (2) is crimped over cable seal (3) as shown.

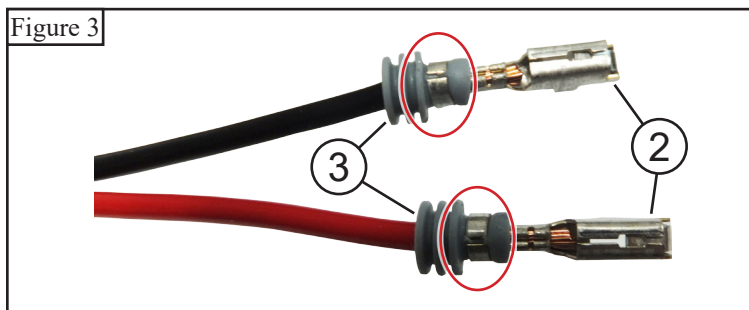

4. Insert crimped terminal ends into connector (1). Insert the black wire into terminal (A) and the red wire into terminal (B) as shown in **Figure 4**.

NOTE: Verify the orientation of the connector (1) and terminals (2). Locking Tabs on the Terminals and on the Connector must be facing the same direction as shown below. Metal terminals should not be forced.

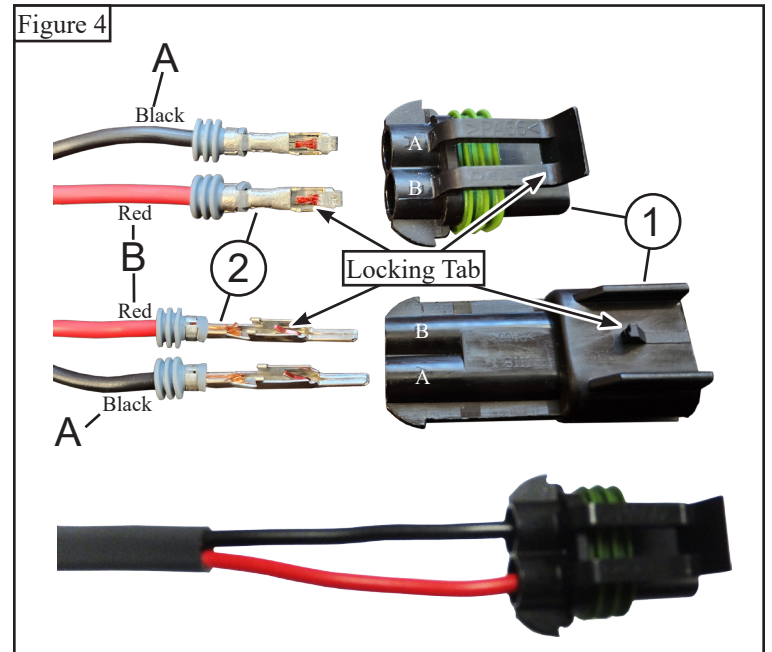

5. Slide lock clip (4) over wires and snap onto connector (1) as shown in **Figure 5**.

